

Technical information

Solphant M

FTM50, FTM51, FTM52

Vibronic



Universal point level switch for fine-grained bulk solids

Application

Solphant M is a robust point level switch for silos with fine-grained or dusty bulk solids even with a low bulk weight.

The various designs mean the device has a wide range of applications.

Many certificates are available for use in dust or gas incensive hazard areas.

FTM50:

Compact design for installation in any position. A wide range of applications thanks to various variations e.g.

- Polished short fork with stainless steel housing (F15) and Tri-Clamp
- Coated standard fork with aluminum housing (F17) and flange
- Standard fork with 280 °C (536 °F) rating and aluminum housing (F13)

FTM51:

With extension pipe up to 4 m (13 ft) for installation in any position

FTM52:

With rope up to 20 m (66 ft) for installation from above

Typical applications:

Cereals, flour, cocoa, sugar, animal feed, detergents, dye powder, chalk, gypsum, cement, plastic granules, fly ash

Your benefits

- Market leader in the area of level detection of bulk solids
- Functional safety up to SIL 2 as per IEC 61508
- No mechanically moving parts: no wear, long operating life
- Insensitive to external vibrations and build-up
- Various electronic inserts: e.g. NAMUR, relay, thyristor and PFM-signal outputs for optimum alignment with the plant control system
- Configurable density setting (bulk weight setting) and switching delay
- Process temperature up to 280 °C (536 °F)
- Choice of coated or polished sensor
- Diagnostic function: warning in the event of impending device failure due to buildup or abrasion

Table of contents

Function and system design	3	Versions with extensions	20
Measuring principle	3	Versions with temperature spacer	21
Measuring system	3	Surface refinement	21
Cable specifications	4	Version with separate housing	22
Immunity to temperature change of connecting cable	4	Weights	23
Connecting cables	4	Materials and surfaces	23
Cable entry	4	Operability	24
Input	4	Display elements	24
Measured variable	4	Operating elements of FEM51, FEM52, FEM54, FEM55, FEM58	25
Measuring range (detection range)	4	Operating elements of FEM57	26
Input signal	4	Sediment detection with FTM50 and FTM51	26
Measuring frequency	4	Certificates and approvals	27
Output	4	CE mark	27
Galvanic isolation	4	Ex approval	27
Switch-on behavior	4	Other standards and guidelines	27
Fail-safe mode	4	RCM-Tick marking	28
Switching delay	5	Pressure Equipment Directive 2014/68/EU (PED)	28
Switch behavior	5	CRN approval	28
Electronic insert	5	EAC conformity	28
FEM51 electronic insert (AC 2-wire)	5	RoHS	28
FEM52 electronic insert (DC PNP)	7	ASME B 31.3	28
FEM54 electronic insert (AC/DC with relay output)	8	Process sealing as per ANSI/ISA 12.27.01	28
FEM55 electronic insert (8/16 mA)	9	Other certificates	28
FEM58 electronic insert (NAMUR H-L edge)	10	Functional safety (SIL validation)	28
FEM57 electronic insert (PFM)	12	Ordering information	29
Installation	13	Soliphant M FTM50	29
Installation instructions	13	Soliphant M FTM51	31
Environment	14	Soliphant M FTM52	33
Ambient temperature range	14	Accessories	35
Storage temperature	14	Removing tool	35
Climate class	14	Weather protection cover	35
Degree of protection	14	Sliding sleeve	35
Vibration resistance	14	Rope shortening kit	35
Shock resistance	14	Documentation	36
Electrical safety	14	Operating Instructions	36
Electromagnetic compatibility	14	Certificates	36
Process	15	Functional safety	36
Medium temperature limits	15		
Thermal shock resistance	15		
Limiting medium pressure range	16		
State of aggregation	16		
Grain size	16		
Bulk weight	16		
Lateral load (static)	16		
Tensile strength rope FTM52	16		
Mechanical construction	17		
Housing and process connection	17		
Dimensions	19		

Function and system design

Measuring principle

A piezoelectric drive excites the tuning fork of Soliphant M to its resonance frequency. If medium covers the tuning fork, the fork's vibrating amplitude changes (the vibration is damped). Soliphant M's electronics compare the actual amplitude with a target value and indicate whether the tuning fork is vibrating freely or whether it is covered by medium.

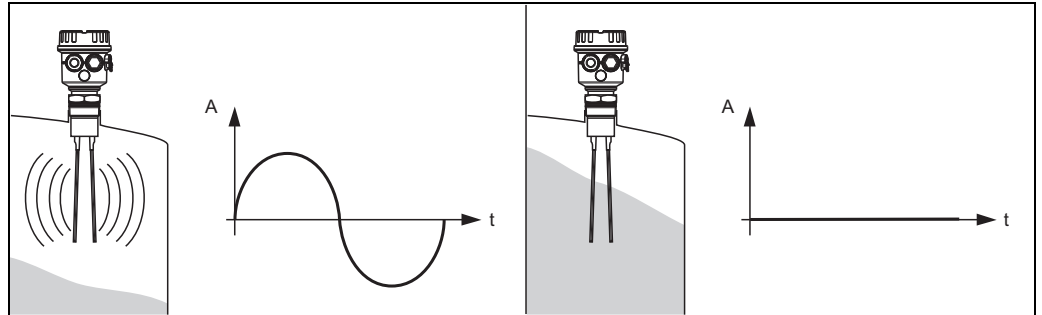

A: Amplitude
t: Time

L00-FTM5xxxx-15-06-xx-xx-001

Measuring system

The measuring system is available either with compact instrumentation or separate instrumentation with a switching unit. The following electronic versions are available:

Compact instrumentation

FEM51:

- Two-wire AC version
- Switch the load directly into the power supply circuit via the thyristor

FEM52:

- Three-wire DC version
- Switch the load via the transistor (PNP) and separate connection

FEM54:

- Universal current version with relay output
- Switch the loads via 2 floating change-over contacts (DPDT)

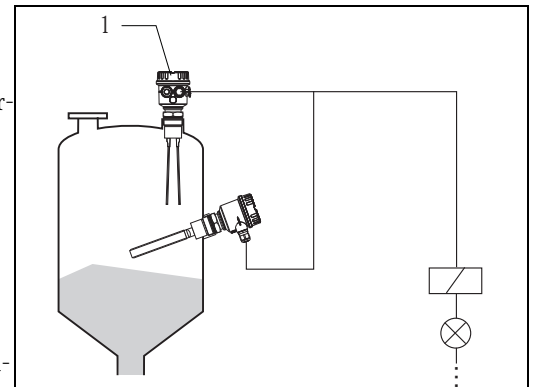

L00-FTM5xxxx-15-05-xx-xx-000

1 Electronic version

Separate instrumentation with switching unit

For connecting to a separate switching unit or isolating amplifier such as Nivotester:

- FTL325N, FTL375N (NAMUR) or
- FTL325P, FTL375P (PFM)

FEM55:

Signal transmission 8/16 mA along two-wire cabling:

FEM57:

- PFM signal transmission
- Current pulses superposed on the power supply along the two-wire cabling
- Self-test from the switching unit without changing levels

FEM58:

- Signal transmission H-L edge 2.2 to 4.8 / 0.4 to 1.0 mA to EN 50227 (NAMUR) along two-wire cabling
- Checking of connecting cabling and other devices by pressing a key on the electronic insert

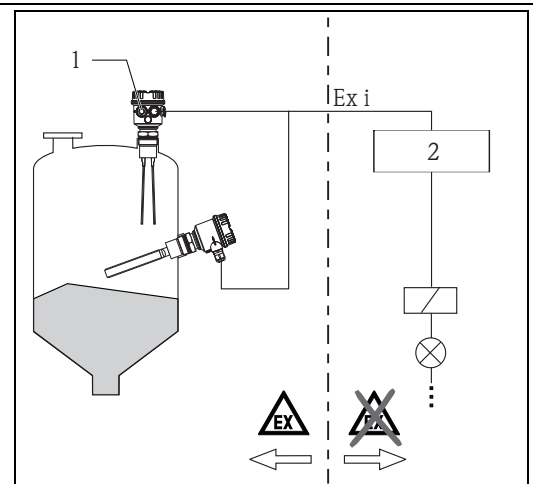

L00-FTM5xxxx-15-05-xx-en-000

1 Electronic version

2 Switching unit, PLC, isolating amplifier, segment coupler

Cable specifications

Within the indicated standards and guidelines to interference immunity (see also "Electromagnetic compatibility", → 14) a normal instrument cable is sufficient. If higher interference levels are present, a shielded cable must be used.

Immunity to temperature change of connecting cable	In non-Ex applications the connecting cables must withstand the ambient temperature +5 K. For Ex applications, the specifications of the respective certificate (XA) must be observed → 36 Certificates.
Connecting cables	<ul style="list-style-type: none"> ▪ Electronic inserts: cross-section max. 2.5 mm² (13 AWG); strand in ferrule to DIN 46228 ▪ Protective ground in housing: cross-section max. 2.5 mm² (13 AWG) ▪ Equipotential bonding connection on housing: cross-section max. 4 mm² (11 AWG)
Cable entry	<p>Housing-specific: screw terminal on electronic insert.</p> <p>Cable gland M20x1,5 for cable:</p> <ul style="list-style-type: none"> ▪ Nickel-plated brass: ø7...10,5 mm (0.28...0.41 in) ▪ Plastic: ø5...10 mm (0.2...0.38 in) ▪ Stainless steel: ø7...12 mm (0.28...0.47 in)

Input

Measured variable	Level (according to the mounting location and the overall length)
Measuring range (detection range)	<ul style="list-style-type: none"> ▪ FTM50: overall length see, → 19 ▪ FTM51: overall length 300 to 4000 mm (11.8 to 157 in) ▪ FTM52: overall length 750 to 20000 mm (29.5 to 787 in) <p>The measuring range of Soliphant M depends on the medium, mounting location and fork length. The detection range is located within the length of the fork.</p> <p>Distinction between the forks:</p> <ul style="list-style-type: none"> ▪ For light media: <ul style="list-style-type: none"> Standard fork with a fork length of 155 mm (6.1 in) (bulk weight of the medium ≥ 10 g/l) ▪ For confined installation conditions, high lateral load or increased buildup: <ul style="list-style-type: none"> Short fork with a fork length of 100 mm (3.94 in) (bulk weight of the medium ≥ 50 g/l)
Input signal	<ul style="list-style-type: none"> ▪ Probes covered => little to no vibrating amplitude ▪ Probes not covered => large vibrating amplitude <p>Selectable frequency monitoring (diagnosis) for detection of abrasion and build-up.</p>
Measuring frequency	<ul style="list-style-type: none"> ▪ Standard fork: approx. 140 Hz (in air) ▪ Short fork: approx. 350 Hz (in air)

Output

Galvanic isolation	<ul style="list-style-type: none"> ▪ FEM51, FEM52, FEM55: Between sensor and power supply ▪ FEM54: Between sensor, power supply and load ▪ FEM57, FEM58: See switching unit connected
Switch-on behavior	When the power supply is switched on the switching status of the outputs corresponds to "signal on alarm". The correct switching status is assumed after a maximum of 3 s.
Fail-safe mode	Minimum/maximum residual current safety selectable on electronic insert. (with FEM57 only at Nivotester).

MAX = maximum safety:

The output switches safety-oriented when the fork is covered (signal on alarm)
For use with overflow prevention for example.

MIN = minimum safety:

The output switches safety-oriented when the fork is uncovered (signal on alarm)
For use with dry running protection for example.

Switching delay	0.5 s when the sensor is covered. Version 150 °C (302 °F): 1.5 s when the sensor is uncovered (1.0 s for short fork) Version 230/280 °C (446/536 °F): 2 s when the sensor is uncovered (1.0 s for short fork) Can be changed to 5 s for covering and uncovering.
Switch behavior	Binary

Electronic insert

FEM51 electronic insert (AC 2-wire)

Power supply

- Supply voltage AC: 19 to 253 V
- Power consumption: < 1.0 W
- Residual current consumption (I_R): < 4 mA; 5.5 mA for short fork (in switch-off moment < 1 mA for 100 ms)
- Short-circuit protection
- Separation voltage: 3.6 kV
- FEM51 overvoltage protection: overvoltage category II

Two-wire AC connection

Always connect in series with a load!

Check the following:

- the residual current consumption in blocked state.
- that for low voltage
 - the voltage drop across the load is such that the minimum terminal voltage at the electronic insert (19 V) when blocked is not undershot.
 - the voltage drop across the electronics when switched through is observed (up to 12 V).
- when selecting the relay, pay attention to the holding power/rated power (see "Connectable load").

* External load "R" must be connected

** AC: U~max. 253 V, 50/60 Hz

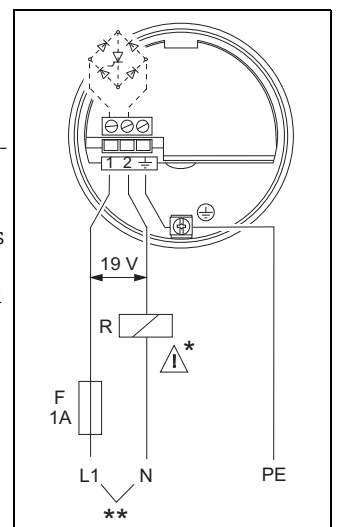



Output signal

I_L = load current (switched through)

I_R = residual current (blocked)

























 = lit

 = flashes

 = unlit

* See also "Operating elements",

→  25

Safety mode	Level	Output signal	LEDs green yellow red
MAX		1 I_L → 2	  
		1 I_R → 2	  
MIN		1 I_L → 2	  
		1 I_R → 2	  
Maintenance required *		1 I_L / I_R → 2	  
Instrument failure		1 I_R → 2	  

L00-FTM5xxxx-04-05-xx-en-001

Signal on alarm

Output signal on power failure or in the event of device failure: I_R

Connectable load

- For relays with a minimum holding power/rated power > 2.5 VA at 253 V (10 mA) or > 0.5 VA at 24 V (20 mA)
- For relays with a maximum holding power/rated power < 89 VA at 253 V or 8.4 VA at 24 V
- Voltage drop across FEM51 max. 12 V
- Residual current with blocked thyristor max. 4 mA (5.5 mA for short fork)
- Load current max. 350 mA (short-circuit proof)

FEM52 electronic insert (DC PNP)

Power supply

- DC voltage: 10 to 55 V
- Ripple: max. 1.7 V, 0 to 400 Hz
- Current consumption: max. 16 mA
- Power consumption: max. 0.86 W
- Reverse polarity protection/short-circuit protection
- Separation voltage: 3.6 kV
- FEM52 overvoltage protection: overvoltage category III

Three-wire DC connection with cable entry / M12 plug

- Preferably used with programmable logic controllers (PLC)
- DI modules as per EN 61131-2
- Positive signal at switching output of the electronics (PNP)

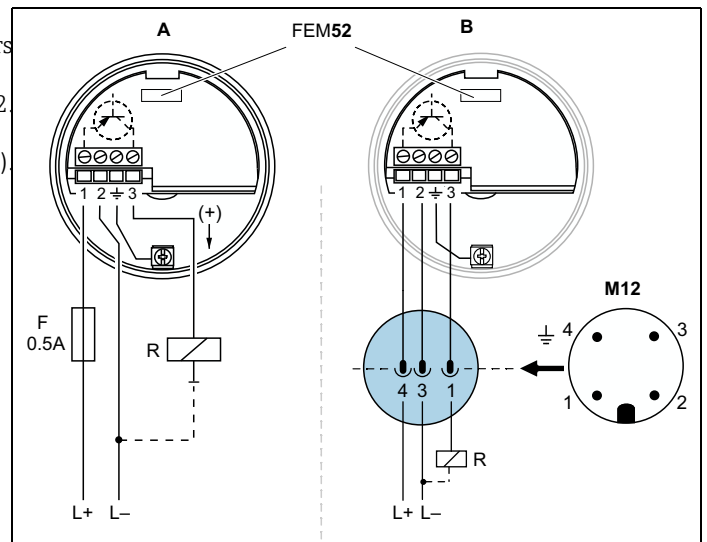

L00-FTM5xxxx-04-05-xx-xx-027a

DC: $U = 10 \text{ V} \dots 55 \text{ V}$

A: With cable entry wired by customer (Ordering feature 80, options 2, 3, 4, 7)

B: With M12 plug wired at the factory (Ordering feature 80, option 1)

Output signal

I_L = load current (switched through)

I_R = residual current (blocked)

= lit

= flashes

= unlit

* See also "Operating elements", → 25

Safety mode	Level	Output signal	LEDs green yellow red
MAX		$L^+ \xrightarrow{I_L} +$ 1 → 3	
		$1 \xrightarrow{I_R} 3$	
MIN		$L^+ \xrightarrow{I_L} +$ 1 → 3	
		$1 \xrightarrow{I_R} 3$	
Maintenance required *		$1 \xrightarrow{I_L / I_R} 3$	
Instrument failure		$1 \xrightarrow{I_R} 3$	

L00-FTM5xxxx-04-05-xx-en-007

Signal on alarm

Output signal on power failure or in the event of device failure: < 100 μA

Connectable load

- Load switched via transistor and separate PNP connection, max. 55 V
- Load current max. 350 mA (pulsed overload and short-circuit protection)
- Residual current < 100 μA (with transistor blocked)
- Capacitance load max. 0.5 μF at 55 V, max. 1.0 μF at 24 V
- Residual voltage < 3 V (with transistor switched through);

**FEM54 electronic insert
AC/DC with relay output)**

Power supply

- Alternating voltage AC: 19 to 253 V, 50/60 Hz
DC voltage: 19 to 55 V
- Power consumption: max. 1.5 W
- Reverse polarity protection/short-circuit protection
- Separation voltage: 3.6 kV
- FEM54 overvoltage protection: overvoltage category II

Universal current connection with relay output (DPDT)

Note!

Please note the different voltage ranges for AC and DC.

Output:

When connecting a device with high inductance, provide a spark arrester to protect the relay contact. A fine-wire fuse (depending on the load connected) protects the relay contact on short-circuiting. The relay contacts switch simultaneously.

* When jumpered, the relay output works with NPN logic.

** See "Connectable load"

- 1 Relay outputs: normally open/closed (NO, NC)
- 2 AC: U~19 to 253 V, DC: U=19 to 55 V

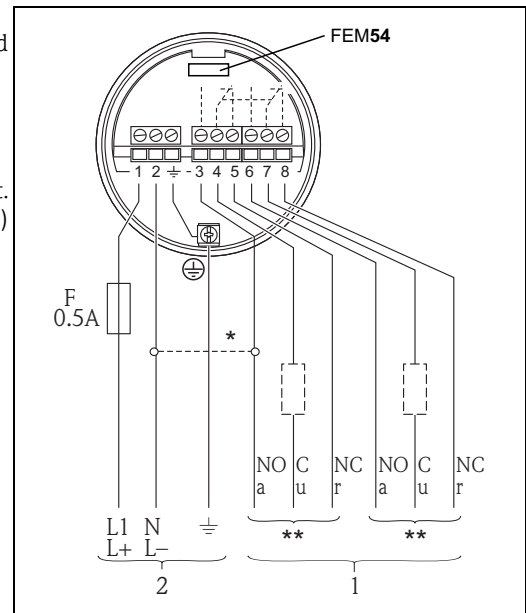

L00-FTM5xxxx-04-05-xx-xx-003

Output signal

⏏ = relay energized

⏏ = relay de-energized

☀ = lit

☀ = flashes

● = unlit

* See also "Operating elements",

→ 25

Safety mode	Level	Output signal	LEDs green yellow red
MAX			☀ ☀ ●
			☀ ● ●
MIN			☀ ☀ ●
			☀ ● ●
Maintenance required *			☀ ● ☀
Instrument failure			☀ ● ☀

L00-FTM5xxxx-04-05-xx-en-008

Signal on alarm

Output signal on power failure or in the event of device failure: relay de-energized

Connectable load

- Loads switched via 2 floating change-over contacts (DPDT)
- AC: I~ max. 6 A (Ex de 4 A), U~ max. 253 V; P~ max. 1500 VA, cos φ = 1, P~ max. 750 VA, cos φ > 0.7
- DC: I= max. 6 A (Ex de 4 A) to 30 V, I= max. 0.2 A to 125 V

- The following applies when connecting a functional low-voltage circuit with double isolation as per IEC 1010: Sum of voltages of relay output and power supply max. 300 V

FEM55 electronic insert (8/16 mA)

Power supply

- DC supply voltage: 11 to 36 V
- Power consumption: < 600 mW
- Reverse polarity protection/short-circuit protection
- Separation voltage: 3.6 kV
- FEM55 overvoltage protection: overvoltage category II

Two-wire connection for separate switching unit with cable entry / M12 plug

For connecting to programmable logic controllers (PLC), AI modules 4-20 mA to EN 61131-2. Output signal jump from high to low current on point level.

Use only power supply with safe galvanically isolation (e.g. SELV).

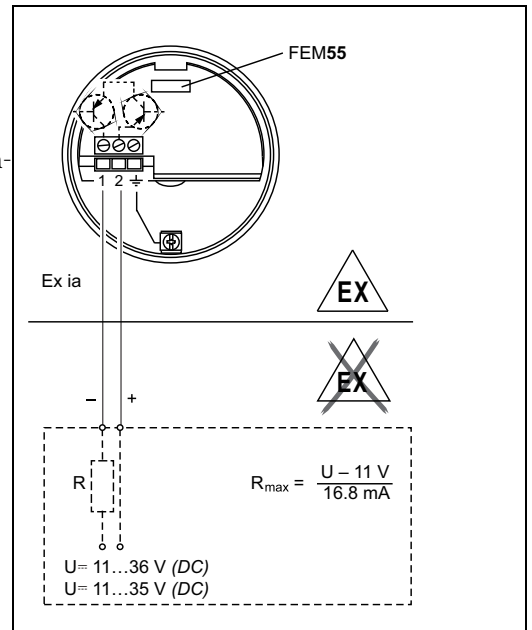

L00-FTM5xxxx-04-05-xx-xx-000

*U= 11 to 36 e.g. PLC
With cable entry wired by customer (Ordering feature 80, options 2, 3, 4, 7)*

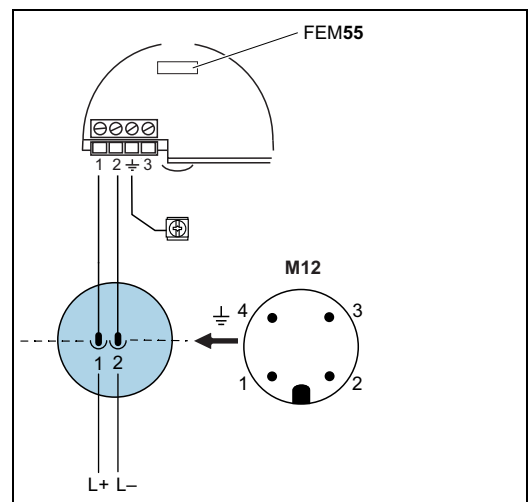

L00-FTM5xxxx-04-05-xx-xx-000a

With M12 plug wired at the factory (Ordering feature 80, option 1)

Output signal

$\sim 16 \text{ mA} = 16 \text{ mA} \pm 5 \%$

$\sim 8 \text{ mA} = 8 \text{ mA} \pm 6 \%$



= lit



= flashes



= unlit

* See also "Operating elements", → 25

Safety mode	Level	Output signal	LEDs		
			green	yellow	red
MAX		$\begin{matrix} + \\ 2 \end{matrix} \xrightarrow{\sim 16 \text{ mA}} 1$			
		$\begin{matrix} + \\ 2 \end{matrix} \xrightarrow{\sim 8 \text{ mA}} 1$			
MIN		$\begin{matrix} + \\ 2 \end{matrix} \xrightarrow{\sim 16 \text{ mA}} 1$			
		$\begin{matrix} + \\ 2 \end{matrix} \xrightarrow{\sim 8 \text{ mA}} 1$			
Maintenance required *		$\begin{matrix} + \\ 2 \end{matrix} \xrightarrow{8/16 \text{ mA}} 1$			
		 3.6 mA			
Instrument failure		$\begin{matrix} + \\ 2 \end{matrix} \xrightarrow{3.6 \text{ mA}} 1$			

L00-FTM5xxxx-04-05-xx-en-006

Signal on alarm

Output signal on power failure or in the event of device failure: $< 3.6 \text{ mA}$

Connectable load

- $R = (U - 11 \text{ V}) / 16.8 \text{ mA}$
- $U =$ connection DC voltage 11 V to 36 V (in wet location DC 11...35 V)

**FEM58 electronic insert
(NAMUR H-L edge)**

Note!

Only in combination with standard fork (fork length 155 mm (6.1 in)).

Power supply

- DC supply voltage: $8.2 \text{ V} \pm 20 \%$
- Power consumption: $< 8 \text{ mW}$ at $I < 1 \text{ mA}$; $< 36 \text{ mW}$ at $I = 2.2$ to 4.8 mA
- Separation voltage: 1.9 kV
- Connection data interface: IEC 60947-5-6

Two-wire connection for separate switching unit with cable entry / M12 plug

For connecting to isolating amplifiers acc. to NAMUR (IEC 60947-5-6), z.B. FTL325N or FTL375N from Endress+Hauser.

H-L edge:

Output signal jump from high to low current on point level.

Additional function:

Test key on the electronic insert.

Pressing the key breaks the connection to the isolating amplifier.

Note!

- For Ex d applications, the additional function can only be used if the housing is not exposed to an explosive atmosphere.
- Connecting to multiplexer: Set clock time to min. 5 s.

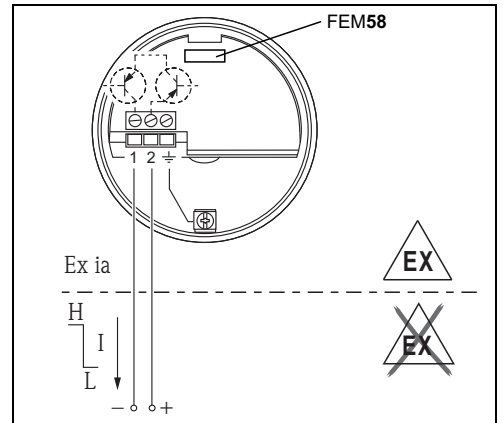

L00-FTM5xxxx-04-05-xx-xx-005

Isolating amplifier to IEC 60947-5-6 (NAMUR)
With cable entry wired by customer (Ordering feature 80, options 2, 3, 4, 7)

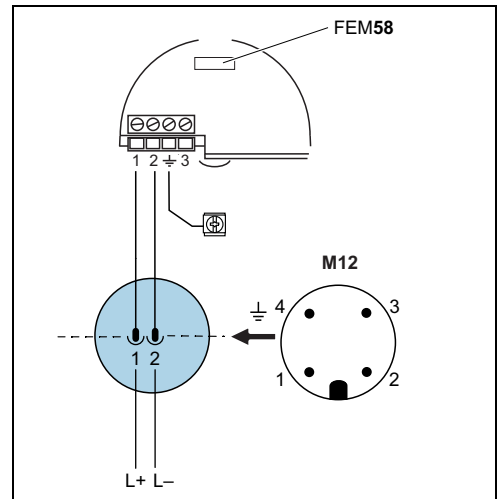

L00-FTM5xxxx-04-05-xx-xx-005a

With M12 plug wired at the factory (Ordering feature 80, option 1)

Output signal

- = lit
- = flashes
- = unlit

* See also "Operating elements", → 25

Safety mode	Level	Output signal	LEDs green yellow red
MAX		+ 2.2 ... 4.8 mA → 1	
		+ 0.4 ... 1.0 mA → 1	
MIN		+ 2.2 ... 4.8 mA → 1	
		+ 0.4 ... 1.0 mA → 1	
Maintenance required *		+ 0.4 ... 4.8 mA → 1	
Instrument failure		+ 0.4 ... 1.0 mA → 1	

L00-FTM5xxxx-04-05-xx-en-012

Signal on alarm

Output signal
in event of device failure: < 1.0 mA

Connectable load

- See "Technical Data" of the isolating amplifier connected according to IEC 60947-5-6 (NAMUR)
- Connection also to safety isolating amplifiers (I = 3 to 4.8 mA)

FEM57 electronic insert (PFM)

Power supply

- DC supply voltage: 9.5 to 12.5 V
- Power consumption: < 150 mW
- Reverse polarity protection/short-circuit protection
- Current consumption: 10 to 13 mA
- Separation voltage: 2.6 kV

Two-wire connection for separate switching unit / M12 plug

For connecting to Nivotester (see graphic) from Endress+Hauser.
Output signal jump of PFM signal from high to low frequency when sensor is covered. Switching between minimum/maximum safety on the Nivotester.

Additional function "self test":
After interruption of the power supply, a test cycle is activated which checks the sensor and electronics without any change in level.
For this purpose, the operating elements must be configured as follows:



The test is activated at the switching unit.
LEDs indicate the progress of the test.

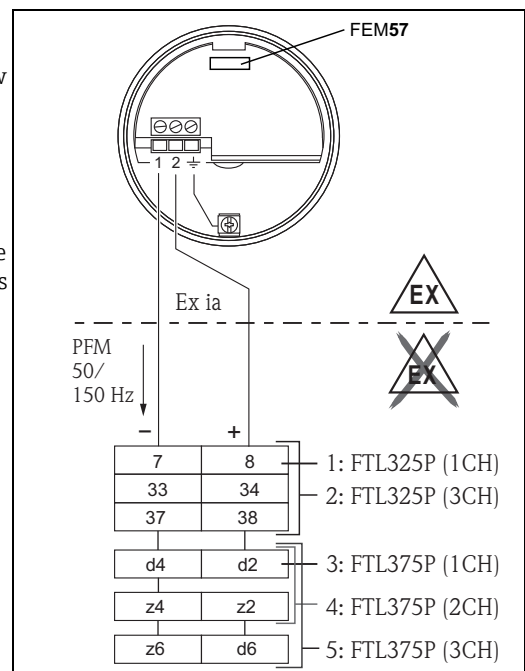



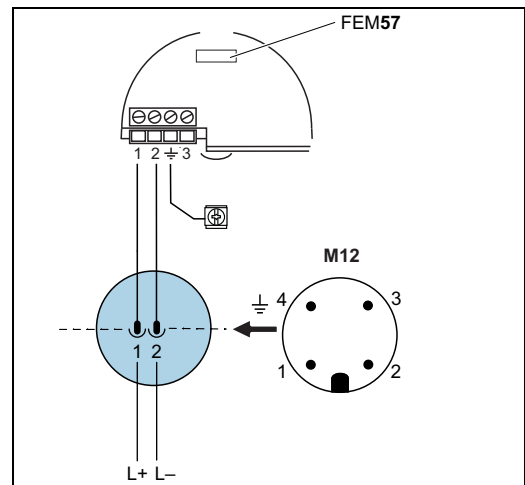

With cable entry wired by customer (Ordering feature 80, options 2, 3, 4, 7)

























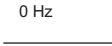

With M12 plug wired at the factory (Ordering feature 80, option 1)

Output signal

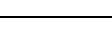
-  = lit
-  = flashes
-  = unlit

* See also "Operating elements", →  25

Safety mode	Level	Output signal (PFM)	LEDs green yellow red
		150 Hz 	  
		50 Hz 	  
Maintenance required *		150 Hz 	  
		 0 Hz 	  
Instrument failure		0 Hz 	  

L00-FTM5xxxx-04-05-xx-en-009

Signal on alarm

Output signal on power failure or in the event of device failure: 0 Hz

Connectable load

- Floating relay contacts in connected switching unit Nivotester (see drawing above)
- For contact load, see the Technical Data of the switching unit

Installation

Installation instructions

Orientation FTM50

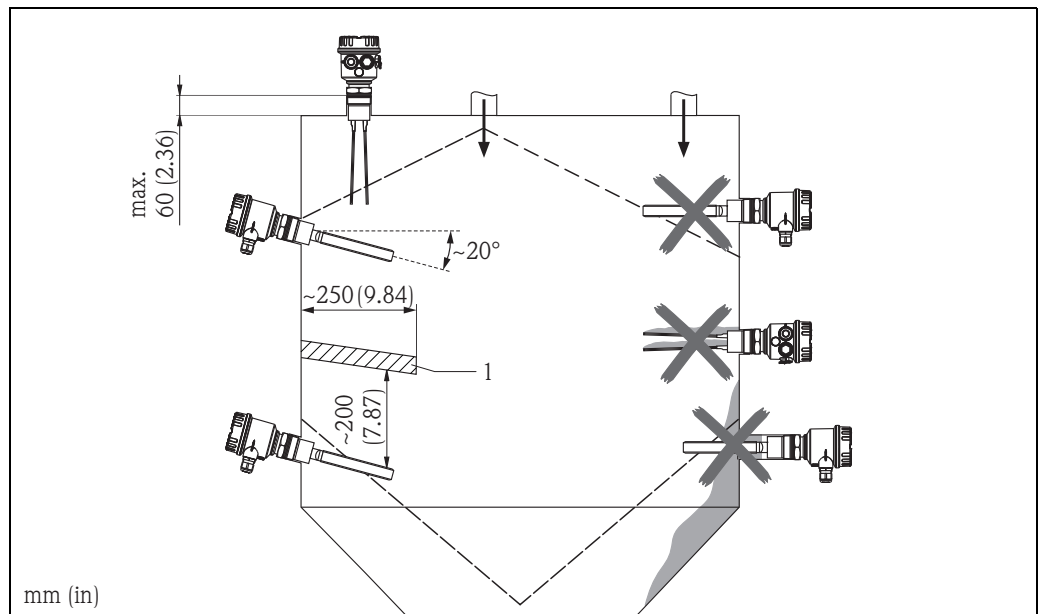

L00-FTM5xxxx-11-06-xx-xx-004

1 Protective cover (provided by the customer)

Orientation
FTM51, FTM52

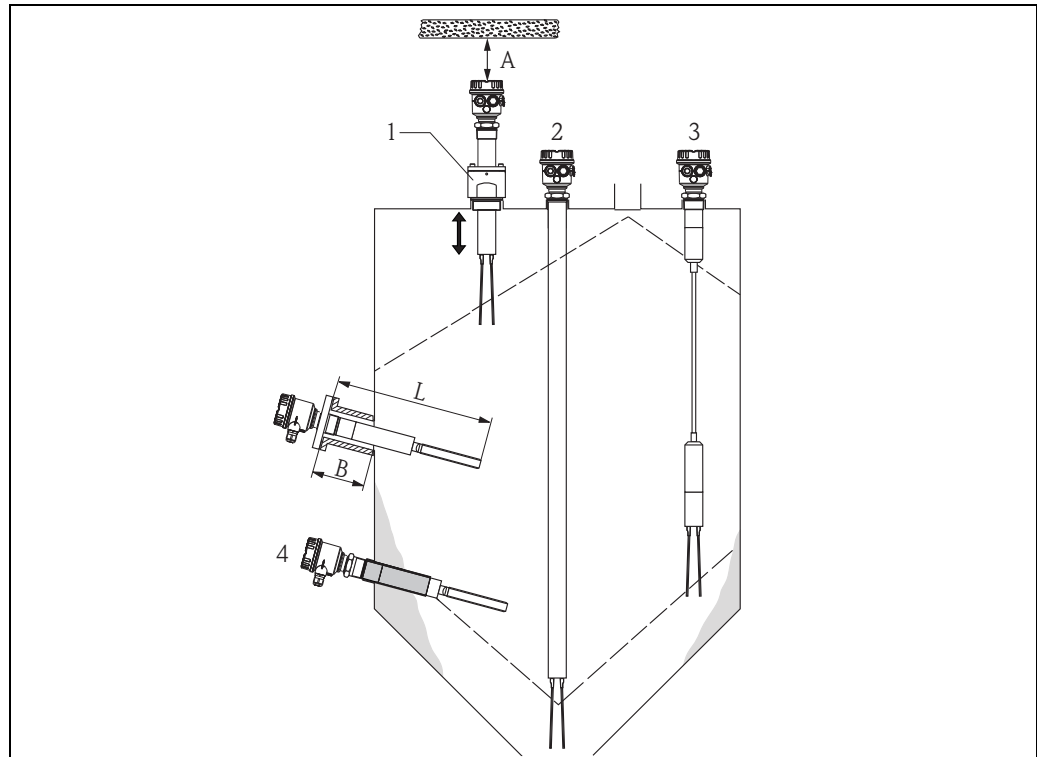

- 1 Sliding sleeve
 2 FTM51
 3 FTM52
 4 FTM51 with supporting tube (not included in the delivery)
 A Clearance
 B Maximum nozzle length: = L Sensor length - 145 mm (5.71 in) for short fork
 = L Sensor length - 200 mm (7.87 in) for standard fork

Environment

Ambient temperature range	-50 °C to +70 °C (-58 °F to +158 °F); With F16 housing: -40 °C to +70 °C (-40 °F to +158 °F)
Storage temperature	-50 °C to +85 °C (-58 °F to +185 °F)
Climate class	Climate protection as per DIN IEC 68, Part 2-38, Fig. 2a
Degree of protection	<ul style="list-style-type: none"> ■ Housing F15, F16, F17, separate housing: IP66/IP67, NEMA4X ■ Housing F13, T13, F27: IP66/IP68, NEMA4X/6P
Vibration resistance	To EN 60068-2-64: 0.01 g ² /Hz
Shock resistance	To EN 60068-2-27: 30 g
Electrical safety	IEC 61010, CAN/CSA-C22.2 No. 61010-1-04 US standard UL 61010-1, 2 nd Edition
Electromagnetic compatibility	<ul style="list-style-type: none"> ■ Interference emission to EN 61326, Equipment Class B, ■ Interference immunity to EN 61326; Annex A (Industrial) and NAMUR Recommendation NE21 (EMC).

Process

Medium temperature limits

Non-hazardous area and Ex d + DIP certificates

(Ex ia certificates see Seite 36, "Certificates")

NOTICE

Permitted ambient temperature T_a at housing depending on the process temperature T_p in the container.

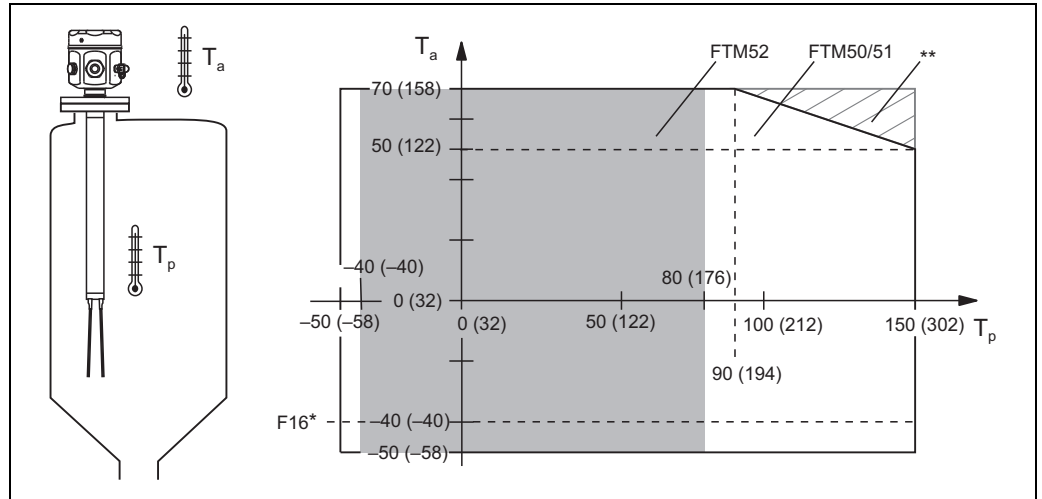

* Restriction to -40 °C with F16 housing

** Additional temperature range for sensors (FTM50, FTM51) with temperature spacer

High temperature (only FTM50, FTM51)

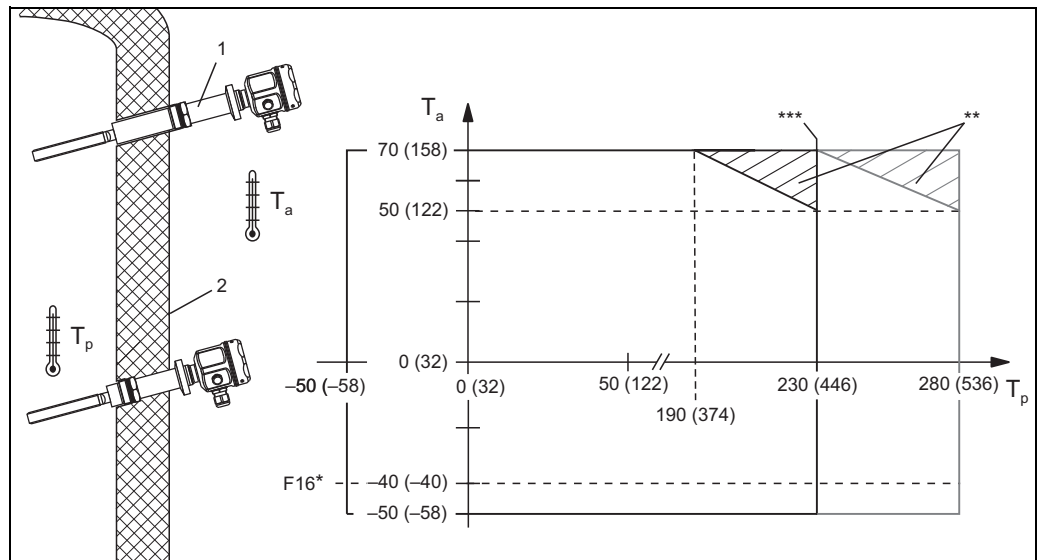

* Restriction to -40 °C with F16 housing

** Additionally utilizable temperature range when using the temperature spacer outside the insulation "1"

*** Antistick coating possible up to max. 230 °C

2 Insulation

Thermal shock resistance

- Maximum 120 K
- At high temperature 260 K

Limiting medium pressure range	-1 to 25 bar (362.5 psi)
	<p>Maximum Working Pressure (MWP)</p> <ul style="list-style-type: none"> ■ FTM50/51: 25 bar (362.5 psi) ■ FTM52: 2 bar (29 psi) (6 bar (87 psi) for Ex d, Ex de and FM/CSA XP) <p>The specified range may be reduced by the selected process connection. The pressure rating (PN) specified on the flanges refers to a reference temperature of 20 °C (68 °F), for ASME flanges to 100 °F. Observe pressure-temperature dependency.</p> <p>The pressure values permitted at higher temperatures can be found in the following standards:</p> <ul style="list-style-type: none"> ■ EN 1092-1: 2001 Tab.18 With regard to their stability-temperature property, the materials 1.4404 and 1.4435 are grouped together under 13E0 in EN 1092-1, Tab. 18. The chemical composition of the two materials can be identical. ■ ASME B 16.5a - 1998 Tab. 2-2.2 F316 ■ ASME B 16.5a - 1998 Tab. 2.3.8 N10276 ■ JIS B 2220
Burst pressure	FTM50/51: 100 bar (1450 psi)

State of aggregation	Solids
Grain size	≤ 10 mm (0.39 in)
Bulk weight	<p>Depends on the density setting on the electronic insert:</p> <ul style="list-style-type: none"> ■ Standard fork: ≥ 10 or 50 g/l (for light media) ■ Short fork: ≥ 50 or 200 g/l (for confined installation conditions, high lateral load or increased buildup)

Lateral load (static) The following graphic shows the maximum permitted lateral load F in N (lbf) in relation to the length L in mm (in).

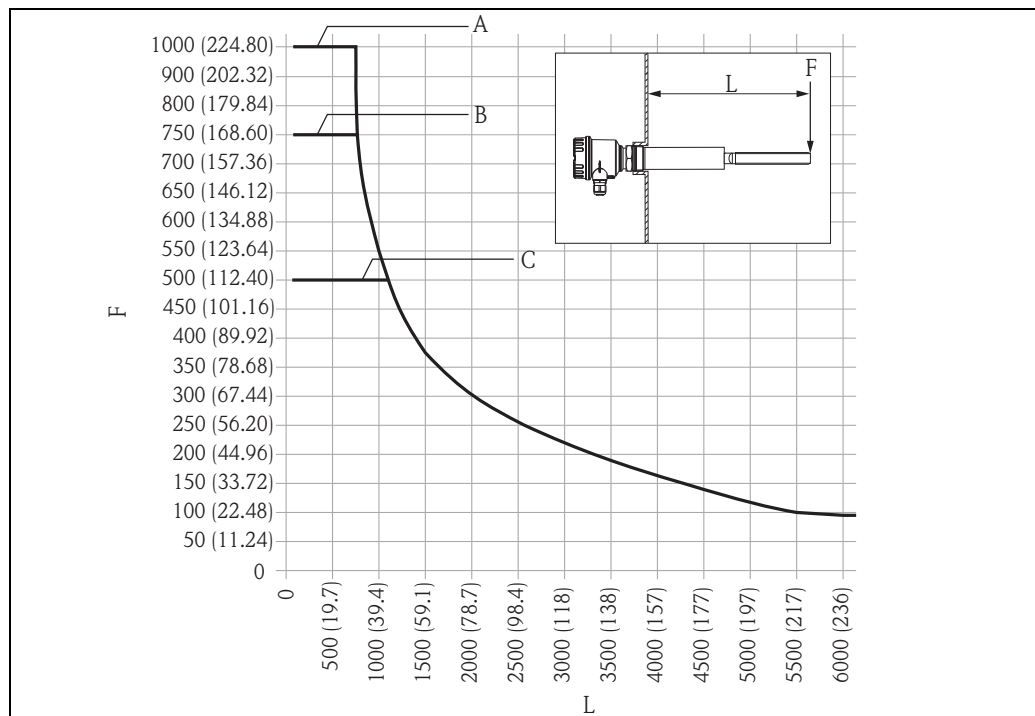

- A Short fork, sensor Ø36 mm (1.42 in), → 19
 B Short fork, sensor Ø43 mm (1.69 in), → 19;
 C Standard fork, sensor Ø43 mm (1.69 in), → 19.

Tensile strength rope FTM52 3000 N (lbf)

Mechanical construction

Housing and process connection

Polyester housing F16

Process connection:

- R 1½
- 1½ NPT
- 1¼ NPT

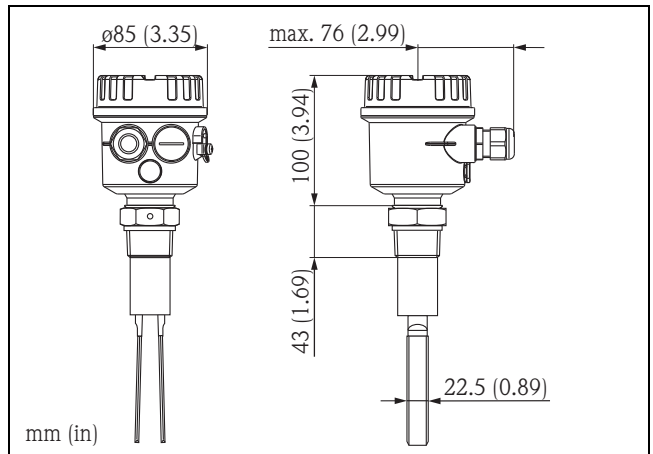

Stainless steel housing F15

Process connection:

Tri-Clamp

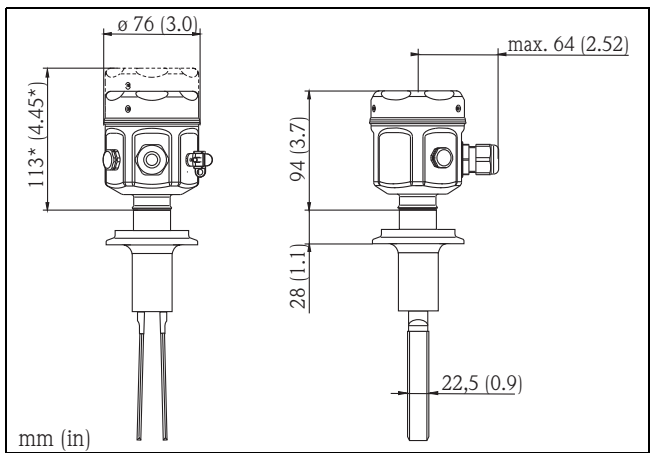

* Cover with glass insert

Aluminum housing F17

Process connection:

Flange

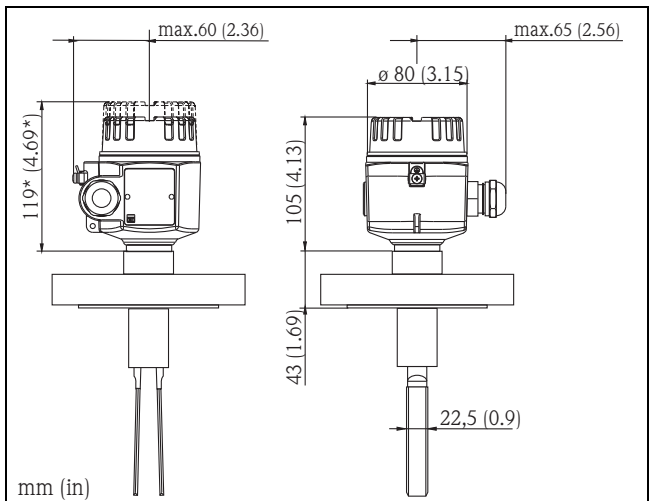

* Cover with glass insert

Aluminum housing F13 (Ex d)
(Adaption to sensor threaded.)

Process connection

- Flange
- R1½
- 1½ NPT
- 1¼ NPT

Stainless steel housing F27 (Ex d)
(Adaption to sensor threaded.)

Process connection

- Flange
- R1½
- 1½ NPT
- 1¼ NPT

* Cover with glass insert
(only for aluminum housing F13)

** For Tri-Clamp 36 mm (1.42 in)

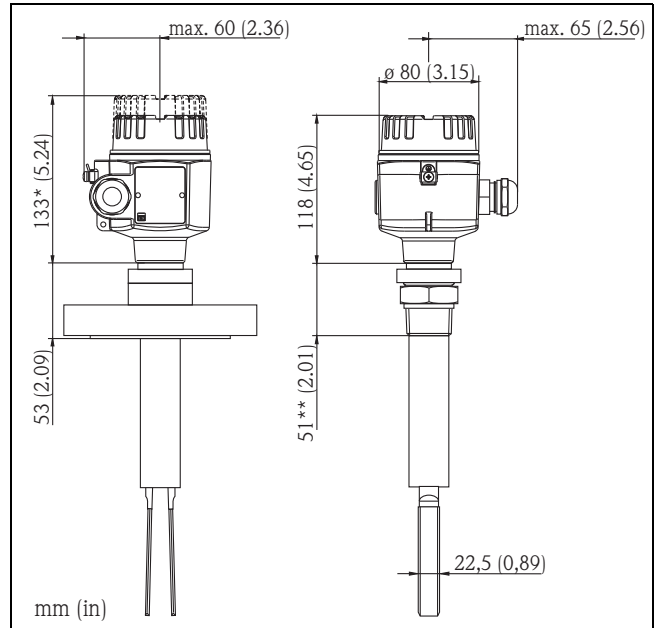

Aluminum housing T13 (Ex de)
With separate connection compartment.

Process connection

- R1½
- 1½ NPT
- 1¼ NPT

With Ex d(e) for FTM51 and FTM52:
for flange and thread dimensions see
the previous graphic

- R 1½
- 1½ NPT
- 1¼ NPT

* Cover with glass insert

** For Tri-Clamp 16 mm (0.63 in)

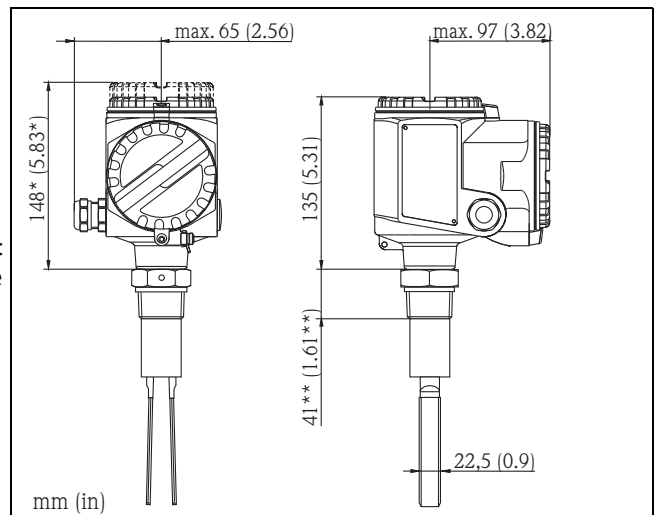

Dimensions

Compact version FTM50

Dimensions: mm (in)

Process connection	Code	Dimensions	Accessories	Pressure Temperature (for FTM50/51)
1½ NPT ANSI B 1.20.1 R 1½ EN 10226	GJ GG	<p>L00-FTM5xxxx-06-05-xx-xx-004</p>		max. 25 bar (362.5 psi) max. 280 °C (536 °F)
1½ NPT ANSI B 1.20.1	GX	<p>L00-FTM5xxxx-06-05-xx-xx-006</p>		max. 25 bar (362.5 psi) max. 150 °C (302 °F)
1¼ NPT ANSI B 1.20.1	GK	<p>L00-FTM5xxxx-06-05-xx-xx-005</p>		max. 25 bar (362.5 psi) max. 150 °C (302 °F)
Flange ANSI B 16.5 EN 1092-1 (DIN 2527 B) JIS B2220	A# B# K#	<p>L00-FTM5xxxx-06-05-xx-xx-013</p>	Seal according to design installed on site FDA approval available	See nominal pressure of flange, however max. 25 bar (362.5 psi) max. 280 °C (536 °F)
Tri-Clamp 2" ISO 2852	TD	<p>L00-FTM5xxxx-06-05-xx-xx-014</p>	Clamping ring and front seal installed on site FDA approval available	max. 16 bar (232 psi) max. 120 °C (248 °F) max. 2 bar (29 psi) max. 150 °C (302 °F)
<p>L00-FTM5xxxx-06-05-xx-xx-030</p> <p>Dimensions of standard fork and short fork</p> <p>¹) Length of standard fork ²) Length of short fork</p>				

Rope version FTM52

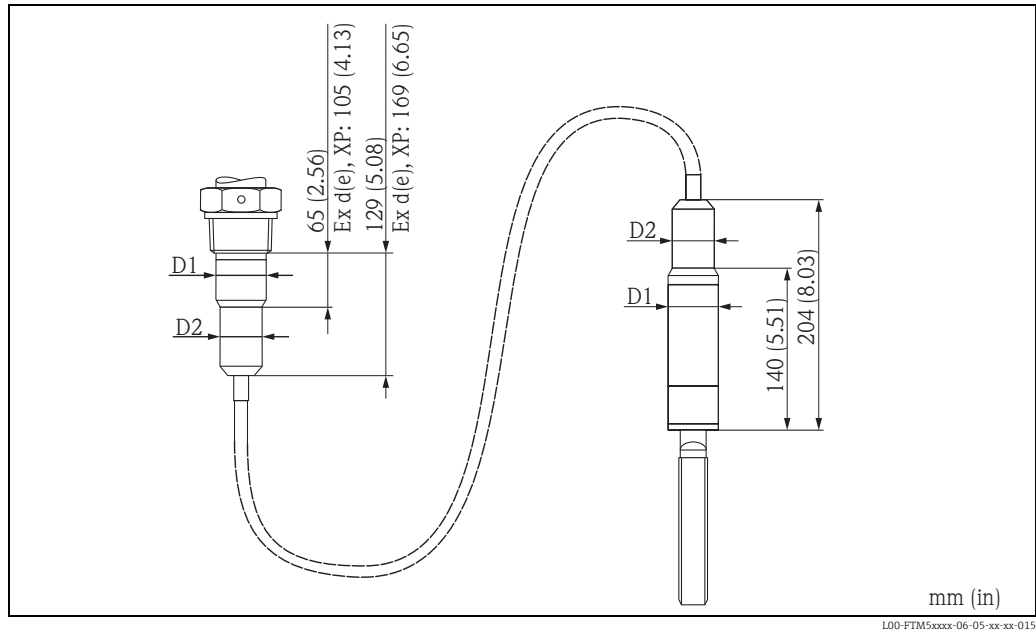

Process connection:	GJ, GG, A#, B#, K#, TD	GK, GX
ø D1 (mm [in])	43 (1.69)	36 (1.42)
ø D2 (mm [in])	37 (1.46)	37 (1.46)

Versions with extensions

FMI51 (pipe): Dimensions depend on process connection and selected pipe extension
FTM52 (rope): Dimensions depend on process connection and selected rope extension

Process connection: <ul style="list-style-type: none"> ▪ 1½ NPT ▪ 1¼ NPT ▪ R 1½ 		Flange and Tri-Clamp	
FTM51	FTM52	FTM51	FTM52
<p>L00-FTM5xxxx-06-05-xx-xx-016</p>	<p>L00-FTM5xxxx-06-05-xx-xx-017</p>	<p>L00-FTM5xxxx-06-05-xx-xx-018</p>	<p>L00-FTM5xxxx-06-05-xx-xx-022</p>
<p>L = Length (from lower edge of thread), X = fork length For further information on the overall length and fork length see "Measuring range (detection range)", → 4. Diameter of pipe extension FTM51: see dimensions of FTM50, → 19.</p>			

Versions with temperature spacer

Length and version depend on temperature and certificate:

150 °C (302 °F)	230 °C (446 °F)	280 °C (536 °F)
L00-FTM5xxxx-06-05-xx-xx-019	L00-FTM5xxxx-06-05-xx-xx-020	L00-FTM5xxxx-06-05-xx-xx-021

mm (in)	150 °C (302 °F)		230 °C (446 °F)	280 °C (536 °F)
L: for housing F15, F16, F17	145 (5.71)	--	175 (6.89)	215 (8.46)
L: for housing F13, F27, T13	145 (5.71)	165 (6.5)	165 (6.5)	205 (8.07)
Certificate	A, 1, 2, 3, 4, 7, 8, C, D, F, X	5, 6, H, Z	Not relevant	Not relevant

Surface refinement

Electropolishing	Device with thread	Device with flange
	L00-FTM5xxxx-06-05-xx-xx-031	L00-FTM5xxxx-06-05-xx-xx-002
	1: Electropolished fork (0.76 µm) 2: Fork and pipe electropolished as far as welding seam on process connection (0.76 µm) NOTICE In the area of the welding seam, the surface roughness depends on the production technique and is not defined.	
Coating	Device with thread	Device with flange
	L00-FTM5xxxx-06-05-xx-xx-032	L00-FTM5xxxx-06-05-xx-xx-003
	1: Fork coated 2: Fork and pipe coated as far as welding seam on process connection 3: Fully coated	

Version with separate housing

Applications:

For high ambient temperatures and applications with confined installation locations (e.g. filling nozzle applications). The cable between the separate housing and sensor can be shortened at the customer's.

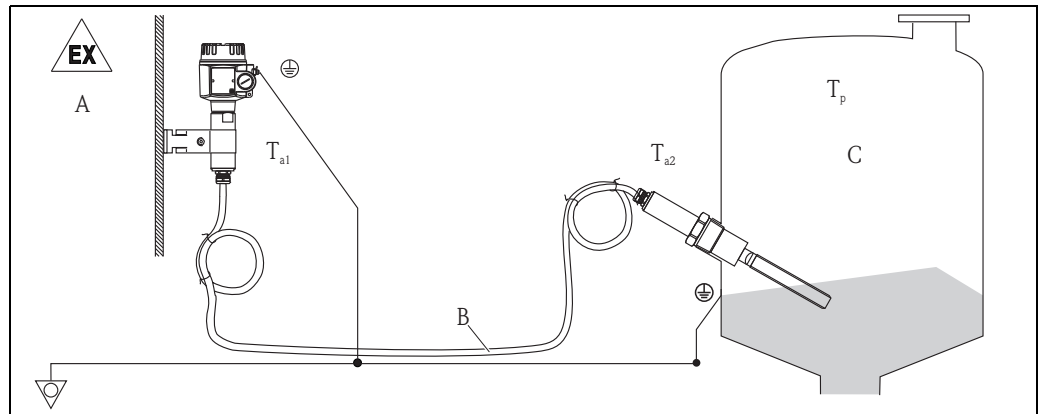

A: Zone 1, Zone 21; B: Length max. 6 m (20 ft); C: Zone 0, Zone 20

	T _{a1}	T _{a2}	T _p
FTM50/51	70 °C (158 °F)	120 °C (248 °F)	Versions: 150 °C (302 °F), 230 °C (446 °F), 280 °C (536 °F)
FTM52	70 °C (158 °F)	80 °C (176 °F)	80 °C (176 °F)

Housing extension heights for wall and pipe mounting

The wall holder unit forms part of the scope of supply for device versions with a separate housing.

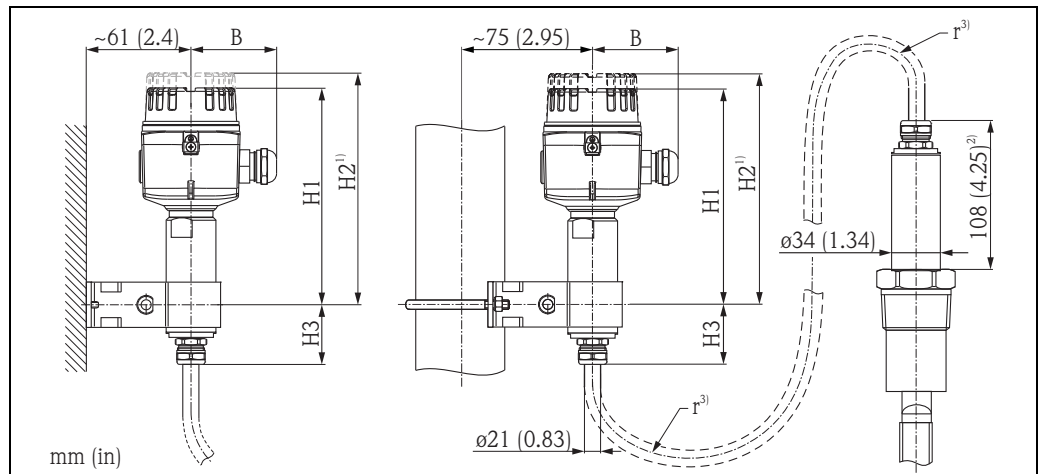

1) Cover with glass insert;

2) - With optional temperature spacer up to 150 °C (302 °F) → 108 + 145 = 253 mm (4.25 + 5.71 = 9.96 in)

- With high-temperature version 230 °C (446 °F) → 108 + 175 = 283 mm (4.25 + 6.89 = 11.1 in)

- With high-temperature version 280 °C (536 °F) → 108 + 215 = 323 mm (4.25 + 8.46 = 12.7 in)

3) The bending radius is $r \geq 100$ mm (3.94 in); with armored tube $r \geq 75$ mm (2.95 in)

Dimen- sions mm (in)	Housing				
	Polyester (F16)	Stainless steel (F15)	Aluminum (F17)	Aluminum (F13) Stainless steel (F27)	Aluminum (T13) Separate connection com- partment
B	76 (2.99)	64 (2.52)	65 (2.56)	65 (2.56)	97 (3.82)
H1	155 (6.1)	166 (6.54)	160 (6.3)	243 (9.57)	260 (10.2)
H2	--	185 (7.28)	174 (6.85)	258 (10.2)	273 (10.7)
H3	41 (1.61)		62 (2.44)		

Weights Depends on type; see last column on "Additional weight" in the ordering information

Materials and surfaces Material specifications as per AISI and DIN-EN.

Surface roughness

NOTICE

In the area of the welding seam, the surface roughness depends on the production technique and is not defined.

Electropolished for simple cleaning and to avoid build-up and corrosion.
Choice of surface roughness (version => type): Ra < 0.76 µm

Parts in contact with process

- Process connection and extension pipe: 316L (1.4404, 1.4435)
- Tuning fork: 316L (1.4404, 1.4435)
- Flanges: 316L (1.4435 or 1.4404)
- PTFE coating: prevents buildup, FDA compliant
- ETFE coating: prevents corrosion
- FTM52: PUR/silicone for rope insulation, PBT

Parts with no process contact

- Seal between process connection/housing: EPDM
- Ground terminals outside on housing: 304 (1.4301), 316L (1.4404)
- Polyester housing F16: PBT-FR with PBT-FR cover or with PA12 transparent cover,
 - Cover seal: EPDM
 - Nameplate glued: polyester film (PET)
 - Pressure compensation filter: PBT-GF20
- Stainless steel housing F15: 316L (1.4404)
 - Cover seal: silicone/PTFE
 - Safety claw: 316L (1.4404)
 - Pressure compensation filter: PA, VMQ/VA
 - Nameplate labeling directly on the device
- Aluminum housing F17/F13: EN-AC-AISi10Mg, plastic-coated,
 - Cover seal: EPDM
 - Safety claw: nickel-plated brass
 - Pressure compensation filter (only F17): silicone
 - Nameplate: 304 (1.4301)
- Stainless steel housing F27: 316L (1.4435)
 - Cover seal: FVMQ (optional: EPDM seal available as spare part)
 - Safety claw: 316L (1.4435)
 - Nameplate: 316L (1.4404)
- Aluminum housing T13: EN-AC-AISi10Mg, plastic-coated,
 - Cover seal: EPDM
 - Safety claw: nickel-plated brass
 - Nameplate: 304 (1.4301)
- Cable gland versions:
 - Polyamide (PA)
 - Nickel-plated brass
 - 316L (1.4435)
 - M12 connector (nickel-plated brass)

Operability

Display elements

NOTICE

The switch settings in the following graphics are in the as-delivered state.

FEM51

- Green LED lit:
 - Indicates operational status
- Yellow LED lit:
 - Indicates switching status
- Red LED
 - flashing: flashes alternately with green LED if maintenance is required
 - lit: indicates device failure

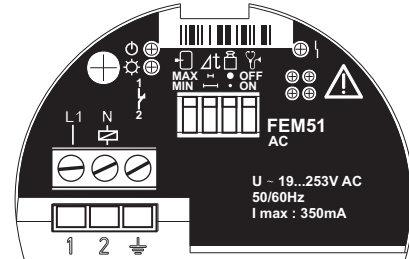

L00-FTM5xxxx-03-05-xx-xx-001

FEM52

- Green LED lit:
 - Indicates operational status
- Yellow LED lit:
 - Indicates switching status
- Red LED
 - flashing: indicates maintenance is required
 - lit: indicates device failure

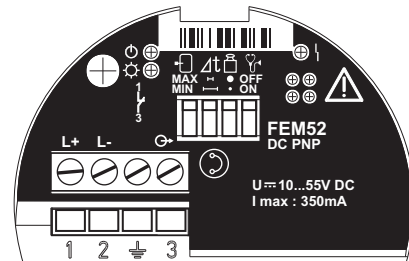

L00-FTM5xxxx-03-05-xx-xx-002

FEM54

- Green LED lit:
 - Indicates operational status
- Yellow LED lit:
 - Indicates switching status
- Red LED
 - flashing: indicates maintenance is required
 - lit: indicates device failure

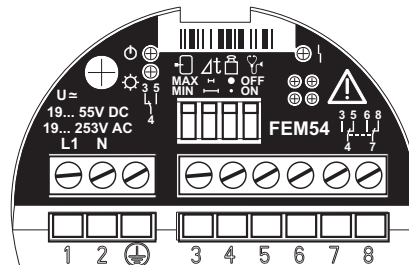

L00-FTM5xxxx-03-05-xx-xx-004

FEM55

- Green LED lit:
 - Indicates operational status
- Yellow LED lit:
 - Indicates switching status
- Red LED
 - flashing: indicates maintenance is required
 - lit: indicates device failure

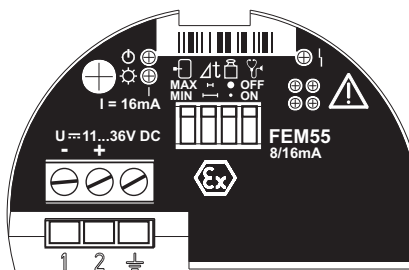

L00-FTM5xxxx-03-05-xx-xx-005

FEM57

- Green LED lit:
Indicates operational status
- Yellow LED lit:
Indicates covered status
- Red LED
 - flashing: indicates maintenance is required
 - lit: indicates device failure

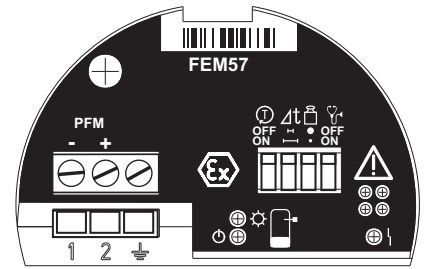

L00-FTM5xxxx-03-05-xx-xx-007

FEM58

- Green LED flashing:
Indicates operational status
- Yellow LED lit:
Indicates switching status
- Red LED
 - flashing: flashes alternately with green LED if maintenance is required
 - flashing: indicates device failure

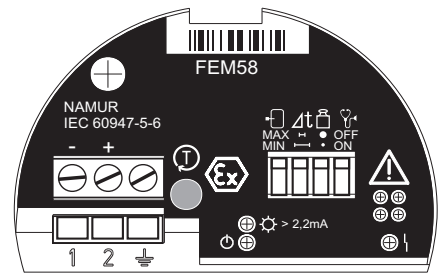

L00-FTM5xxxx-03-05-xx-xx-008

NOTICE

If the test key is pressed this breaks the cable connection.

Operating elements of FEM51, FEM52, FEM54, FEM55, FEM58

Factory setting:

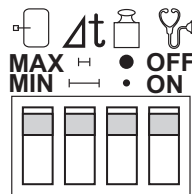

L00-FTM5xxxx-19-05-xx-xx-001

	Switch for safety mode	
	MAX	Overfill prevention
	MIN	Dry running protection
	Switch for switching delay	
	H	0.5 s when covered 150 °C (302 °F): 1.5 s when uncovered (short fork 1 s) 230/280 °C (446/536 °F): 2 s when uncovered (short fork 1 s)
	H	5 s when covered, 5 s when uncovered
	Switch for bulk weight/density setting	
	●	50 g/l standard fork, 200 g/l short fork (high bulk weight)
	•	10 g/l standard fork, 50 g/l short fork (low bulk weight)
	Switch for diagnosis	
	OFF	Diagnosis of abrasion and buildup switched OFF
	ON	Diagnosis of abrasion and buildup switched ON <ul style="list-style-type: none"> ■ For additional density setting to high bulk density: abrasion and build-up are indicated per LED at the electronic insert only ■ For additional density setting to low bulk density: output of "signal on alarm" for abrasion and build-up

Operating elements of FEM57

Factory setting:

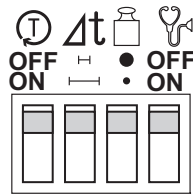

L00-FTM5xxxx-19-05-xx-xx-002

	Switch for switching the self-test on or off	
	OFF	Self-test switched off
	ON	At the same time, switching delay 0.5 s when covered, density setting for low bulk weight and diagnostics on (see also Seite 12): Self-test performed when voltage returns.
	Switch for switching delay	
	H	0.5 s when covered 150 °C (302 °F): 1.5 s when uncovered (short fork 1 s) 230/280 °C (446/536 °F): 2 s when uncovered (short fork 1 s)
	H	5 s when covered, 5 s when uncovered
One switch for bulk weight/density setting		
	●	Standard fork: 50 g/l Short fork: 200 g/l (high bulk weight)
	•	Standard fork: 10 g/l (low bulk weight) Short fork: 50 g/l
One switch for diagnosis		
	OFF	Diagnosis of abrasion and buildup switched OFF
	ON	Diagnosis of abrasion and buildup switched ON <ul style="list-style-type: none"> ■ For additional density setting to high bulk density: abrasion and build-up are indicated per LED at the electronic insert only ■ For additional density setting to low bulk density: output of "signal on alarm" for abrasion and build-up

Sediment detection with FTM50 and FTM51

Detection of solids under water

Only sediment is detected.
Water-like liquids or entrained substances are not detected.

The standard version of FTM52 is not suitable for immersion due to the IP67 rope seal!
Version with IP68 available on request.

Hinweis!

Switching sensitivity decreases if a short fork is used.

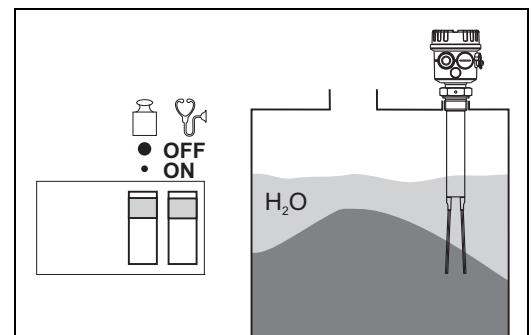

L00-FTM5xxxx-19-05-xx-xx-014

Certificates and approvals

CE mark

The measuring system is in conformity with the statutory requirements of the applicable EC Directives. These are listed in the corresponding EC Declaration of Conformity along with the standards applied. Endress+Hauser confirms successful testing of the device by affixing to it the CE mark.

Ex approval

FEM51, FEM52, FEM54, FEM55:

- Explosion protection for potentially explosive gas/air mixtures:
Ex d, Ex de, XP, intrinsically safe sensor circuit Ex ia, IS
- Explosion protection for potentially explosive dust/air mixtures:
Dust ignition-proof as per EN 50281-1-1, DIP as per EN 61241-0

FEM57, FEM58:

- Explosion protection for potentially explosive gas/air mixtures:
Ex ia, IS (intrinsically safe power supply + intrinsically safe sensor circuit)
- Explosion protection for potentially explosive dust/air mixtures:
Ex ia D, IS (intrinsically safe power supply + intrinsically safe sensor circuit)

See "Ordering information", → [29](#) and "Documentation", → [36](#).

Your Endress+Hauser distributor will supply you with information about hazardous area versions that are currently available.

All explosion protection data are given in a separate documentation (see "Documentation") which is available upon request. Copies of certificates available upon request.

	F16 housing	F15 housing	F17 housing	F13 / F27 housing	T13 housing with separate connection compartment	Separate housing
Dust ignition-proof	X (except II 1/2 D)	X	X	X	X	X
Ex ia	X	X	X	X	X	X
Ex nA/nL/nC	X	X	X	X	X	X
Ex d	-	-	-	X	X	X
Ex de	-	-	-	-	X	X
IP66/67	X	X	X	-	-	X
IP66/68	-	-	-	X	X	-
Recommended in event of severe external vibrations	-	-	-	X	X	X
Goretex filter	X	X	X	-	-	-

Other standards and guidelines

Other standards and guidelines that were taken into consideration in designing and developing Soliphant M FTM50, FTM51, FTM52:

- Low Voltage Directive (73/23/EEC)
- DIN EN 61010 Part 1, 2001
Protection Measures for Electrical Equipment for Measurement, Control, Regulation and Laboratory Procedures
Part 1: General requirements
- EN 61326
Electrical Equipment for Measurement, Control and Laboratory Use
EMC requirements

RCM-Tick marking

The supplied product or measuring system meets the ACMA (Australian Communications and Media Authority) requirements for network integrity, interoperability, performance characteristics as well as health and safety regulations. Here, especially the regulatory arrangements for electromagnetic compatibility are met. The products are labelled with the RCM- Tick marking on the name plate.



A0029561

Pressure Equipment Directive 2014/68/EU (PED)**Pressure instruments with permitted pressure ≤ 200 bar (2 900 psi)**

Pressure instruments with permitted pressure ≤ 200 bar (2 900 psi) Pressure instruments with a flange and threaded boss that do not have a pressure-bearing housing do not fall within the scope of the Pressure Equipment Directive, irrespective of the maximum permitted pressure.

Reason:

According to Article 2, point 5 of EU Directive 2014/68/EU, pressure accessories are defined as "devices with an operational function and having pressure-bearing housings".

If a pressure instrument does not have a pressure-bearing housing (no identifiable pressure chamber of its own), there is no pressure accessory present within the meaning of the Directive.

CRN approval

CRN-approved devices are fitted with a separate plate bearing the registration number No.: OF10907:5C ADD1.

EAC conformity

The measuring system meets the legal requirements of the applicable EAC guidelines. These are listed in the corresponding EAC Declaration of Conformity together with the standards applied. Endress+Hauser confirms successful testing of the device by affixing to it the EAC mark.

RoHS

The measuring system complies with the substance restrictions of the EU Directive on the restriction of the use of certain hazardous substances 2011/65/EU (RoHS 2).

ASME B 31.3

Design and materials in accordance with ASME B31.3. The welding seams are through-penetration welded and comply with ASME Boiler and Pressure Vessel Code Section IX and EN ISO 15614-1.

Process sealing as per ANSI/ISA 12.27.01

North American practice for the installation of process seals.

Soliphant M instruments are designed by Endress+Hauser according to ANSI/ISA 12.27.01 as single seal devices with annunciation, allowing the user to waive the use and save the cost of installing external secondary process seals in the conduit as required by the process sealing sections of ANSI/NFPA 70 (NEC) and CSA 22.1 (CEC). The instruments comply with the North American installation practice and provide a very safe and cost-saving installation for pressurized applications with hazardous fluids. Please refer to the Safety Instructions (XA) of the relevant device for further information → 36ff.

Product	Type	Maximum process pressure	Marking	Approval
Soliphant M	FTM50-D/F/H##...	25 bar (362.5 psi)	Single Seal	FM, CSA
	FTM51-D/F/H##...	25 bar (362.5 psi)	Single Seal	FM, CSA
	FTM52-D/F/H##...	2 bar (29 psi)	Single Seal	FM, CSA

Other certificates

- Material certificate as per EN 10204/3.1 for all wetted parts,
- AD2000 on request
- TSE Certificate of Suitability
 - The following applies to wetted device components:
 - They do not contain any materials derived from animals.
 - No additives or operating materials derived from animals are used in production or processing.

Functional safety (SIL validation)

Use in safety systems requiring functional safety to SIL2 in accordance with IEC 61508. See "Documentation", → 36.

Ordering information

NOTICE

This overview does not mark options which are mutually exclusive.

Soliphant M FTM50

Basic weight: (F16 housing, thread R 1½, fork 100 mm, 50g/l): 1.1 kg (2.43 lbs)

010	Approval	
A	Non-hazardous area	
C	CSA General Purpose, CSA C/US	
D	FM DIP-AIS Cl. II, III, Div. 1, Gr. E-G + CSA DIP Cl. II, III, Div. 1+2, Gr. E-G, Zone 2, 21, 22	
E	IEC Ex iaD A20, IEC Ex ia IIC T6	
F	FM IS Cl. I, II, III, Div. 1, Gr. A-G + NI + CSA IS Cl. I, II, III, Div. 1+2, Gr. A-G, FM: Zone 0, 1, 2, 20, 21, 22; CSA: Zone 0, 1, 2	
G	IEC Ex tD A20/A21	
H	FM XP-AIS Cl. I, Div. 1, Gr. A-D + CSA XP Cl. I, Div. 1+2, Gr. A-D, FM: Zone 1, 2, 21, 22; CSA: Zone 1, 2	
K	IEC Ex d IIC T6 Ga/Gb	
L	IEC Ex de IIC T6 Ga/Gb	
M	INMETRO Ex tb IIIC Da/Db	
P	INMETRO Ex d IIC T6-T2 Ga/Gb, Ex ta/tb IIIC Da/Db	
Q	INMETRO Ex de IIC T6-T2 Ga/Gb, Ex ta/tb IIIC Da/Db	
R	EAC Ex de IIC T6 Ga/Gb, Ex t IIIC Da/Db	
S	TIIS Ex d IIC T3	
T	TIIS Ex ia IIC T3	
U	Non-hazardous area + EAC marking	
V	EAC Ex d IIC T6 Ga/Gb, Ex t IIIC Da	
W	EAC Ex ia IIIC Da/Db, Ex ia IIC T6 Ga/Gb	
X	NEPSI Ex ia IIC T2-T6	
Z	NEPSI Ex d IIC T2-T6	
8	NEPSI DIP A20/A21 TA, T* IP66	
1	ATEX II 1 D, 1/2 GD, 1/3 GD Ex ia IIC T6	
2	ATEX II 1/2 D Ex tD	
3	ATEX II 3 D, ATEX II 3 G Ex nA/nL/nC	
4	ATEX II 1/3 D Ex tD	
5	ATEX II 1 D, ATEX II 1/2 G Ex de [ia] IIC T6	
6	ATEX II 1 D, ATEX II 1/2 G Ex d [ia] IIC T6	
7	ATEX II 1 G/D, Ex ia IIC T6, note Safety Instructions (XA)!	
Y	Special version, TSP-No. to be spec.	

020	Process connection	Additional weight
AF	2" 150 lbs, RF, flange ANSI B16.5	2.5 kg
AG	3" 150 lbs, RF, flange ANSI B16.5	5.0 kg
AH	4" 150 lbs, RF, flange ANSI B16.5	7.1 kg
B3	DN50, PN25/40 A, flange EN1092-1 (DIN2527 B)	3.3 kg
BS	DN80, PN10/16 A, flange EN1092-1 (DIN2527 B)	4.9 kg
BT	DN100, PN10/16 A, flange EN1092-1 (DIN2527 B)	5.7 kg
GG	Thread EN10226 R 1½	-
GJ	Thread ANSI NPT 1½, d = 1.67" sensor	-
GK	Thread ANSI NPT 1¼, d = 1.38" sensor	-
GX	Thread ANSI NPT 1½, d = 1.38" sensor to suit ISA nozzle	-
KF	10K 50A, RF, flange JIS B2220	1.8 kg
KG	10K 80A, RF, flange JIS B2220	3.3 kg
KH	10K 100A, RF, flange JIS B2220	4.4 kg
TD	Tri-Clamp ISO2852, DN40-51 (2")	-
YY	Special version, TSP-No. to be spec.	-

030	Material; surface refinement	
A	PTFE>316L; fork coated, reduces build-up, no corrosion protection	
B	PTFE>316L; completely coated, reduces build-up, no corrosion protection	
C	ETFE>316L; completely coated	
2	316L; Ra ≤ 3.2 µm/126 µin, without	
5	316L; Ra ≤ 0.76 µm/30 µin, fork electropolished	
7	316L; Ra ≤ 0.76 µm/30 µin, fork + tube electropolished	
9	Special version, TSP-No. to be spec.	

040	Fork; bulk weight	Additional weight
A	155 mm/6 in; min. 10 g/l	0.1 kg
K	100 mm/4 in; min. 50 g/l	-
Y	Special version, TSP-No. to be spec.	-

050										Electronics; output		
										1	FEM51; 2-wire 19 to 253 VAC	
										2	FEM52; 3-wire PNP 10 to 55 VDC	
										4	FEM54; relay DPDT 19 to 253 VAC/55 VDC	
										5	FEM55; 8/16 mA 11 to 36 VDC	
										7	FEM57; 2-wire PFM	
										8	FEM58; NAMUR + test key (H-L signal)	
										9	Special version, TSP-No. to be spec.	
060										Probe design	Additional weight	
										A	Compact	-
										D	6 m cable > separate housing	2.4 kg
										E	20 ft cable > separate housing	2.4 kg
										G	6 m cable, armored > separate housing	5.0 kg
										H	20 ft cable, armored > separate housing	5.0 kg
										Y	Special version, TSP-No. to be spec.	
070										Housing	Additional weight	
										H	T13, aluminum, IP66/68, NEMA4X, separate connection compartment	1.1 kg
										1	F16, polyester IP66/67, NEMA4X + cover with sight glass	-
										3	F17, aluminum, IP66/67, NEMA4X	0.4 kg
										5	F13, aluminum, IP66/68, NEMA4X	0.5 kg
										6	F27, 316L IP67/68, NEMA Type 4X/6P Encl.	0.5 kg
										7	F15, 316L, Hygiene, IP66/67, NEMA4X	0.1 kg
										Y	Special version, TSP-No. to be spec.	
080										Cable entry		
										1	M12 plug	
										2	Gland M20 (Ex d > thread M20)	
										3	Thread NPT ½	
										4	Thread G ½	
										7	Thread NPT ¾	
										9	Special version, TSP-No. to be spec.	
090										Additional options 1	Additional weight	
										A	Not selected	-
										G	Glass cover	0.1 kg
										R	Glass cover, SIL Declaration of Conformity	0.1 kg
										S	SIL Declaration of Conformity	-
										Y	Special version, TSP-No. to be spec.	
100										Additional options 2	Additional weight	
										A	Not selected	-
										C	EN10204-3.1 material (wetted), inspection certificate	-
										D	Temperature spacer ≤ 150 °C	0.4 kg*
										E	Temperature spacer ≤ 150 °C, EN10204-3.1 material (wetted), inspection certificate	0.4 kg*
										F	High temperature ≤ 280 °C	1.0 kg
										H	High temperature ≤ 280 °C, EN 10204-3,1 material (wetted), inspection certificate	1.0 kg
										J	High temperature ≤ 230 °C	0.9 kg
										K	High temperature ≤ 230 °C, EN 10204-3,1 material (wetted), inspection certificate	0.9 kg
										Y	Special version	
											* For Ex d / Ex de / XP (certificate 5, 6, H, Z): 0.9 kg	
995										Identification		
										1	Measuring point (TAG), see additional specifications	
FTM50											Complete product designation	
-												

Soliphant M FTM51

Basic weight: (F16 housing, thread R 1½, length 300 mm, 50 g/l): 1.4 kg (3.09 lbs)

010		Approval		
A	Non-hazardous area			
C	CSA General Purpose, CSA C/US			
D	FM DIP-AIS Cl. II, III, Div. 1, Gr. E-G + CSA DIP Cl. II, III, Div. 1+2, Gr. E-G, FM: Zone 21, 22			
E	IEC Ex iaD A20, IEC Ex ia IIC T6			
F	FM IS Cl. I, II, III, Div. 1, Gr. A-G + NI + CSA IS Cl. I, II, III, Div. 1+2, Gr. A-G, FM: Zone 0, 1, 2, 20, 21, 22; CSA: Zone 0, 1, 2			
G	IEC Ex tD A20/A21			
H	FM XP-AIS Cl. I, Div. 1, Gr. A-D + CSA XP Cl. I, Div. 1+2, Gr. A-D, FM: Zone 1, 2, 21, 22; CSA: Zone 1, 2			
K	IEC Ex d IIC T6 Ga/Gb			
L	IEC Ex de IIC T6 Ga/Gb			
M	INMETRO Ex tb IIIC Da/Db			
P	INMETRO Ex d IIC T6-T2 Ga/Gb, Ex ta/tb IIIC Da/Db			
Q	INMETRO Ex de IIC T6-T2 Ga/Gb, Ex ta/tb IIIC Da/Db			
R	EAC Ex de IIC T6 Ga/Gb, Ex t IIIC Da/Db			
S	TIIS Ex d [ia] IIC T4			
T	TIIS Ex ia IIC T3			
U	Non-hazardous area + EAC marking			
V	EAC Ex d IIC T6 Ga/Gb, Ex t IIIC Da			
W	EAC Ex ia IIIC Da/Db, Ex ia IIC T6 Ga/Gb			
X	NEPSI Ex ia IIC T2-T6			
Z	NEPSI Ex d [ia] IIC T2-T6			
8	NEPSI DIP A20 Ta, T4			
1	ATEX II 1 D, 1/2 GD, 1/3 GD Ex ia IIC T6			
2	ATEX II 1/2 D Ex tD			
3	ATEX II 3 D, ATEX II 3 G Ex nA/nL/nC			
4	ATEX II 1/3 D Ex tD			
5	ATEX II 1 D, ATEX II 1/2 G Ex de [ia] IIC T6			
6	ATEX II 1 D, ATEX II 1/2 G Ex d [ia] IIC T6			
7	ATEX II 1 G/D, Ex ia IIC T6, note Safety Instructions (XA)!			
Y	Special version, TSP-No. to be spec.			
020		Process connection		Additional weight
AF	2" 150 lbs, RF, flange ANSI B16.5			2.5 kg
AG	3" 150 lbs, RF, flange ANSI B16.5			5.0 kg
AH	4" 150 lbs, RF, flange ANSI B16.5			7.1 kg
B3	DN50, PN25/40 A, flange EN1092-1 (DIN2527 B)			3.3 kg
BS	DN80, PN10/16 A, flange EN1092-1 (DIN2527 B)			4.9 kg
BT	DN100, PN10/16 A, flange EN1092-1 (DIN2527 B)			5.7 kg
GG	Thread EN10226 R 1½			-
GJ	Thread ANSI NPT 1½, d = 1.67" sensor			-
GK	Thread ANSI NPT 1¼, d = 1.38" sensor			-
GX	Thread ANSI NPT 1½, d = 1.38" sensor to suit ISA nozzle			-
KF	10K 50A, RF, flange JIS B2220			1.8 kg
KG	10K 80A, RF, flange JIS B2220			3.3 kg
KH	10K 100A, RF, flange JIS B2220			4.4 kg
TD	Tri-Clamp ISO2852, DN40-51 (2")			-
YY	Special version, TSP-No. to be spec.			-
030		Material; surface refinement		
A	PTFE>316L; fork coated, reduces build-up, no corrosion protection			
B	PTFE>316L; completely coated, reduces build-up, no corrosion protection			
C	ETFE>316L; completely coated			
2	316L; Ra ≤ 3.2 µm/126 µin, without			
5	316L; Ra ≤ 0.76 µm/30 µin, fork electropolished			
7	316L; Ra ≤ 0.76 µm/30 µin, fork + tube electropolished			
9	Special version, TSP-No. to be spec.			
040		Length; bulk weight		Additional weight
L	...			2.0 kg/m*
	mm; min. 10 g/l			
M	...			2.0 kg/m*
	mm; min. 50 g/l			
P	... in; min. 10 g/l			5.1 kg/100 in*
Q	... in; min. 50 g/l			5.1 kg/100 in*
S	... mm; min. 10 g/l, surface refinement			2.0 kg/m*
T	... mm; min. 50 g/l, surface refinement			2.0 kg/m*

Soliphant M FTM52

Basic weight: (F16 housing, thread R 1½, length 1000 mm, 50 g/l): 2.2 kg (4.85 lbs)

010	Approval	
A	Non-hazardous area	
C	CSA General Purpose, CSA C/US	
D	FM DIP-AIS Cl. II, III, Div. 1, Gr. E-G + CSA DIP Cl. II, III, Div. 1+2, Gr. E-G, FM: Zone 21, 22	
E	IEC Ex iaD A20, IEC Ex ia IIC T6	
F	FM IS Cl. I, II, III, Div. 1, Gr. A-G + NI + CSA IS Cl. I, II, III, Div. 1+2, Gr. A-G, FM: Zone 0, 1, 2, 20, 21, 22; CSA: Zone 0, 1, 2	
G	IEC Ex tD A20/A21	
H	FM XP-AIS Cl. I, Div. 1, Gr. A-D + CSA XP Cl. I, Div. 1+2, Gr. A-D, FM: Zone 1, 2, 21, 22; CSA: Zone 1, 2	
K	IEC Ex d IIC T6 Ga/Gb	
L	IEC Ex de IIC T6 Ga/Gb	
M	INMETRO Ex tb IIIC Da/Db	
P	INMETRO Ex d IIC T6-T2 Ga/Gb, Ex ta/tb IIIC Da/Db	
Q	INMETRO Ex de IIC T6-T2 Ga/Gb, Ex ta/tb IIIC Da/Db	
R	EAC Ex de IIC T6 Ga/Gb, Ex t IIIC Da/Db	
S	TIIS Ex d [ia] IIC T6	
U	Non-hazardous area + EAC marking	
V	EAC Ex d IIC T6 Ga/Gb, Ex t IIIC Da	
W	EAC Ex ia IIIC Da/Db, Ex ia IIC T6 Ga/Gb	
X	NEPSI Ex ia IIC T6	
Z	NEPSI Ex d [ia] IIC T6	
8	NEPSI DIP A20/A21 TA, T* IP66	
1	ATEX II 1D, 1/2 GD, 1/3 GD Ex ia IIC T6	
2	ATEX II 1/2 D Ex tD [iaD]	
3	ATEX II 3D, ATEX II 3 G Ex nA/nL/nC	
4	ATEX II 1/3 D Ex tD [iaD]	
5	ATEX II 1 D, ATEX II 1/2 G Ex de [ia] IIC T6	
6	ATEX II 1 D, ATEX II 1/2 G Ex d [ia] IIC T6	
7	ATEX II 1G/D Ex ia IIC T6, note Safety instructions (XA)!	
Y	Special version, TSP-No. to be spec.	
020	Process connection	Additional weight
AF	2", 150 lbs, RF, flange ANSI B16.5	2.5 kg
AG	3", 150 lbs, RF, flange ANSI B16.5	5.0 kg
AH	4", 150 lbs, RF, flange ANSI B16.5	7.1 kg
B3	DN50, PN25/40 A, flange EN1092-1 (DIN2527 B)	3.3 kg
BS	DN80, PN10/16 A, flange EN1092-1 (DIN2527 B)	4.9 kg
BT	DN100, PN10/16 A, flange EN1092-1 (DIN2527 B)	5.7 kg
GG	Thread EN10226 R 1½	-
GJ	Thread ANSI NPT 1½, d = 1.67" sensor	-
GK	Thread ANSI NPT 1¼, d = 1.38" sensor	-
GX	Thread ANSI NPT 1½, d = 1.38" sensor to suit ISA nozzle	-
KF	10K 50A, RF, flange JIS B2220	1.8 kg
KG	10K 80A, RF, flange JIS B2220	3.3 kg
KH	10K 100A, RF, flange JIS B2220	4.4 kg
TD	Tri-Clamp ISO2852, DN40-51 (2")	-
YY	Special version, TSP-No. to be spec.	-
030	Material; surface refinement	
A	PTFE>316L; fork coated, reduces build-up, no corrosion protection	
2	316L; Ra ≤ 3.2 µm/126 µin, without	
5	316L; Ra ≤ 0.76 µm/30 µin, fork electropolished	
9	Special version, TSP-No. to be spec.	
040	Length; bulk weight	Additional weight
B	... mm; min. 10 g/l	1.3 kg/10 m
C	... mm; min. 50 g/l	1.3 kg/10 m
F	... in; min. 10 g/l	1.7 kg/500 in
G	... in; min. 50 g/l	1.7 kg/500 in
Y	Special version, TSP-No. to be spec.	
050	Electronics; output	
1	FEM51; 2-wire 19 to 253 VAC	
2	FEM52; 3-wire PNP 10 to 55 VDC	
4	FEM54; relay DPDT 19 to 253 VAC/55 VDC	

050										Electronics; output		
										5	FEM55; 8/16 mA 11 to 36 VDC	
										7	FEM57; 2-wire PFM	
										8	FEM58; NAMUR + test key (H-L signal)	
										9	Special version, TSP-No. to be spec.	
060										Probe design	Additional weight	
										A	Compact	-
										D	6 m cable > separate housing	2.4 kg
										E	20 ft cable > separate housing	2.4 kg
										G	6 m cable, armored > separate housing	5.0 kg
										H	20 ft cable, armored > separate housing	5.0 kg
										Y	Special version, TSP-No. to be spec.	
070										Housing	Additional weight	
										H	T13, aluminum, IP66/68, NEMA4X, separate connection compartment	1.1 kg
										1	F16, polyester IP66/67, NEMA4X + cover with sight glass	-
										3	F17, aluminum, IP66/67, NEMA4X	0.4 kg
										5	F13, aluminum, IP66/68, NEMA4X	0.5 kg
										6	F27, 316L IP67/68, NEMA Type 4X/6P Encl.	0.5 kg
										7	F15, 316L, Hygiene, IP66/67, NEMA4X	0.1 kg
										Y	Special version, TSP-No. to be spec.	
080										Cable entry		
										1	M12 plug	
										2	Gland M20 (Ex d > thread M20)	
										3	Thread NPT ½	
										4	Thread G ½	
										7	Thread NPT ¾	
										9	Special version, TSP-No. to be spec.	
090										Additional options 1	Additional weight	
										A	Not selected	-
										G	Glass cover	0.1 kg
										R	Glass cover, SIL Declaration of Conformity	0.1 kg
										S	SIL Declaration of Conformity	-
										Y	Special version, TSP-No. to be spec.	
100										Additional options 2		
										A	Not selected	
										Y	Special version, TSP-No. to be spec.	
995										Identification		
										1	Measuring point (TAG)	
FTM52											Complete product designation	
-												

Accessories

Removing tool

For Soliphant M FTM50, FTM51, FTM52.
Order No.: 71026213

Weather protection cover

For Soliphant M FTM50, FTM51, FTM52
with F13, F17 and F27 housing.
Order No.: 71040497

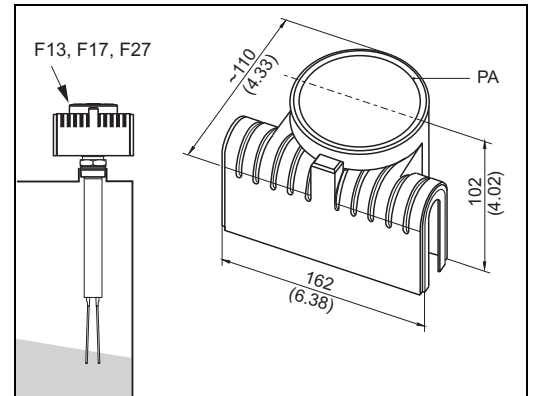

L00-FTM5xxxx-03-05-xx-xx-009

Sliding sleeve

Only for Soliphant M FTM51 with pipe diameter $d=43$ mm (1.69 in), see product structure, ordering feature "Process connection", options GG, GJ and ordering feature "Material", options A, 2, 5 (→ 31).

For pressurized containers.

Sliding sleeve version:

- G2
DIN ISO 228/1
Order No.: 52024631
- 2NPT
ANSI B 1.20.1
Order No.: 52024630

NOTICE

Suitable for switch point configuration!

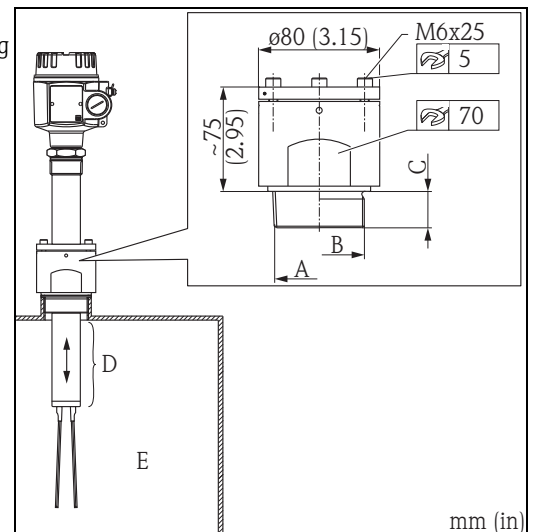

mm (in)

L00-FTM5xxxx-03-05-xx-xx-002

- A G2 (316L)
- B 2NPT (316L)
- C For G2: 24 mm (0.94 in); for 2NPT: 27.5 mm (1.08 in)
- D MWP = 25 bar (362.5 psi)
- E $T_p = \text{max. } 280^\circ\text{C } (536^\circ\text{F})$

Rope shortening kit

Only for Soliphant M FTM52.
Order No.: 52024632

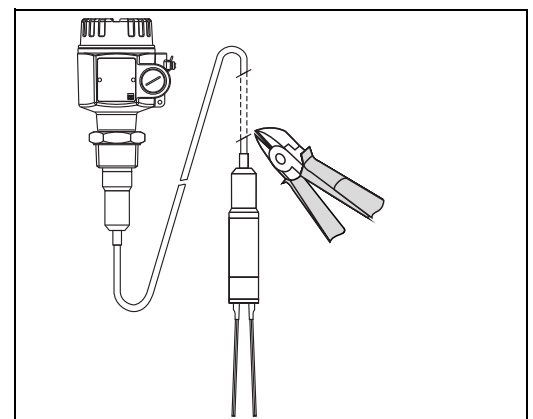

L00-FTM5xxxx-00-00-xx-xx-001

Documentation

NOTICE

You can find the following supplementary documentation on our product pages at www.endress.com.

Operating Instructions	▪ Soliphant M FTM50, FTM51			KA00229F
	▪ Soliphant M FTM52			KA00230F
	▪ Soliphant M FTM51, sliding sleeve, pressurized:			KA00239F
	▪ Soliphant M FTM52, rope shortening			KA00231F
	▪ Soliphant M FTM50, FTM51, FTM52			
	– Separate housing; installation and shortening instructions (housing side)			KA00264F
	– Separate housing and armored tube; installation and shortening instructions (housing side)			KA00265F
	– Separate housing; removing and installing the sensor			KA00273F
Certificates	ATEX			
	▪ ATEX II	Ex i	1D, 1/2D, 1G, 1/2G	XA00305F
	▪ ATEX II	Ex i (X)	1D, 1G	XA00319F
	▪ ATEX II	Ex d/Ex de	1D, 1/2D Ex t, 1/2G	XA00306F
	▪ ATEX II	Ex t	1/2D, 1/3D	XA00307F
	▪ ATEX II	Ex t, Ex n	3D, 3G	XA00331F
	NEPSI			
	▪ NEPSI	Ex t		XA00393F
	▪ NEPSI	Ex ia		XA00393F
	▪ NEPSI	Ex d, Ex t		XA00395F
	IECEX			
	▪ IECEX	Ex ia		XA00391F
	▪ IECEX	Ex t		XA00392F
	▪ IECEX	Ex d, Ex de, Ex t		XA00633F
	INMETRO			
	▪ INMETRO	Ex t		XA01336F
	▪ INMETRO	Ex d, Ex de, Ex t		XA01354F
	EAC			
	▪ EAC	Ex d, Ex t	Ga/Gb, Da/Db	XA01590F
	FM			
	▪ FM	IS, NI		XA01337F
	CSA			
	▪ CSA	IS, NI		XA01248F
▪ CSA	XP, DIP		XA01042F	
Functional safety	▪ Soliphant M + electronic insert FEM51			SD00203F
	▪ Soliphant M + electronic insert FEM52			SD00204F
	▪ Soliphant M + electronic insert FEM54			SD00205F
	▪ Soliphant M + electronic insert FEM55			SD00208F
	▪ Soliphant M + electronic insert FEM57 + Nivotester FTL325P			SD00207F
	▪ Soliphant M + electronic insert FEM58			SD00206F



71368903

www.addresses.endress.com
